

Portable DVD Player with Swivel Screen

User's Manual



Questions? Need some help?

This manual should help you understand your new product.

If you still have questions, call our help line found on the insert with this icon:





Or visit
www.polaroid.com/support.

Important Safety Instructions



CAUTION: TO REDUCE THE RISK OF ELECTRIC SHOCK, DO NOT REMOVE COVER (OR BACK). NO USE-SERVICEABLE PARTS INSIDE. REFER SERVICING TO QUALIFIED SERVICE PERSONNEL.

	<p>The lightning flash with arrowhead symbol, within an equilateral triangle, is intended to alert the user to the presence of uninsulated “dangerous voltage” within the product’s enclosure that may be of sufficient magnitude to constitute a risk of electrical shock.</p>
	<p>The exclamation point within an equilateral triangle is intended to alert the user to the presence of important operating and maintenance (servicing) instructions in the literature accompanying the appliance.</p>

WARNING: TO REDUCE THE RISK OF FIRE OR ELECTRIC SHOCK, DO NOT EXPOSE THIS APPLIANCE TO RAIN OR MOISTURE.



Caution: Laser radiation when open. Do not stare into beam.

CAUTION: USE OF ANY CONTROLS, ADJUSTMENTS, OR PROCEDURES OTHER THAN THOSE SPECIFIED HEREIN MAY RESULT IN HAZARDOUS RADIATION EXPOSURE.

Power Supply:

Connect the supplied power adapter to the side of the DVD player in the slot marked “DC In”. Plug the two-prong end of the power cord to an AC outlet. If you have difficulty inserting the plug, turn it over and reinsert it; if the player will not be used for a long time, disconnect the power from the outlet.

Note: before plugging in the power cord to an AC outlet, make sure that all the connections have been made.

Important Safety Instructions

CAUTION: These servicing instructions are for use by qualified service personnel only. To reduce the risk of electric shock, do not perform any servicing other than that contained in the operating instructions unless you are qualified to do so.

Refer to service manual for servicing instructions.

1. Read these instructions.
2. Keep these instructions.
3. Heed all warnings.
4. Follow all instructions.
5. Do not use this apparatus near water.
6. Clean only with dry cloth.
7. Do not block any ventilation openings. Install in accordance with the manufacturer's instructions.
8. Do not install near any heat sources such as radiators, heat registers, stoves, or other apparatus (including amplifiers) that produce heat.
9. Do not defeat the safety purpose of the polarized or grounding-type plug. A polarized plug has two blades with one wider than the other. A grounding-type plug has two blades and a third grounding prong. The wide blade or the third prong is provided for your safety. If the provided plug does not fit in your outlet, consult an electrician for replacement of the obsolete outlet.
10. Protect the power cord from being walked on or pinched particularly at plugs, convenience receptacles, and at the point where they exit the apparatus.
11. Only use attachments/accessories specified by the manufacturer.
12. Use only with the cart, stand, tripod, bracket, or table specified by the manufacturer or sold with the apparatus. When a cart is used, use caution when moving the car/apparatus to avoid injury from tip-over.
13. Unplug this apparatus during lightening storms or when unused for long periods of time.
14. Refer all servicing to qualified personnel. Servicing is required when the apparatus has been damaged in any way, which as power-supply cord or plug is damaged, liquid has been spilled or objects have fallen into the apparatus, the apparatus has been exposed to rain or moisture, does not operate normally, or has been dropped.



Note: Do not touch the color TFT LCD screen by hand directly.

Important Safety Instructions

Copyright Protection

This product incorporates copyright protection technology that is protected by U.S. patents and other intellectual property rights. Use of this copyright protection technology must be authorized by Macrovision, and is intended for home and other limited viewing uses only unless otherwise authorized by Macrovision. Reverse engineering or disassembly is prohibited.

IMPORTANT FOR LASER PRODUCTS

- 1. CLASS 1 LASER PRODUCT**
- 2. DANGER:** Visible laser radiation when open and interlock failed or defected. Avoid direct exposure to beam.
- 3. CAUTION:** Do not open the top cover. There are no user serviceable parts inside the player. Leave all servicing to qualified personnel.

Region Code Information

DVD players and discs are coded by region. If the region number described on the DVD disc does not correspond to the region number of this product, this product cannot play the disc.

WEEE

This product contains electrical or electronic materials. The presence of these materials may, if not disposed of properly, have potential adverse effects on the environment and human health. Presence of this label on the product means it should not be disposed of as unsorted waste and must be collected separately. As a consumer, you are responsible for ensuring that this product is disposed of properly. To find out how to properly dispose of this product, please go to **www.polaroid.com** and click on “**Company**” or call the customer service number for your country listed in the instruction manual.



Features

High-quality Audio and Video

- **Excellent Sound:** Dolby Digital Decoder delivers great sound.
- **AV Input:** External audio, video can be connected to most external AV sources.
- **AV Output:** Analog audio output can be connected to external amplifier.

Advanced Playing Functions

- **Compatibility:** Compatible with DVD, CD, and JPEG discs, etc.
- **On-Screen Display:** You can choose English, French, Spanish, etc. for the on-screen display language.
- **Particular Performance:** Multi-speed, fast forward, fast backward, slow playback, and repeated playback.
- **Search by Time:** Search for a certain track of a disc by selected time.
- **Last Memory Playback:** Memorizes the stopped playback track and continues playing the disc from this spot when the power remains on. (Only available for DVD and CD discs.)
- **Special Functions:** Supports screen multi-angle viewing and zooming functions.

Other Special Functions

- **High Resolution:** MPEG-2 decoding format achieves more than 500 lines of horizontal resolution.
- **Power Adapter Switch:** Automatically adapts to voltage requirements in UK and other countries.

Accessories

Your portable DVD player may not include all accessories listed below.
To purchase additional accessories for your player, visit www.polaroid.com.

ITEM	NAME
	Remote Control (with battery)
	Power Supply Cord with AC Adaptor
	Rechargeable Battery Pack
	DC Adapter (Car Adapter)
	Audio/Video Cord
	Headphone
	Carrying Case / Car Bag
	Operation Manual

Note: Accessories and their parts numbers are subject to change without prior notice.

Contents

Important Safety Instructions	2
Features	5
Accessories	6
View of Front Panel	8
View of Side Panel	9
View of Bottom Panel	10
Revolving LCD Screen	11
Remote Control	12
System Connections	14
Power Supply	15
Rechargeable Battery	16
Notes on Discs	18
Playback Operation	19
DVD Playback	20
CD Playback	21
JPEG Playback	22
System Setup	24
Definitions	26
Troubleshooting	27
Specifications	28

View of Front Panel*

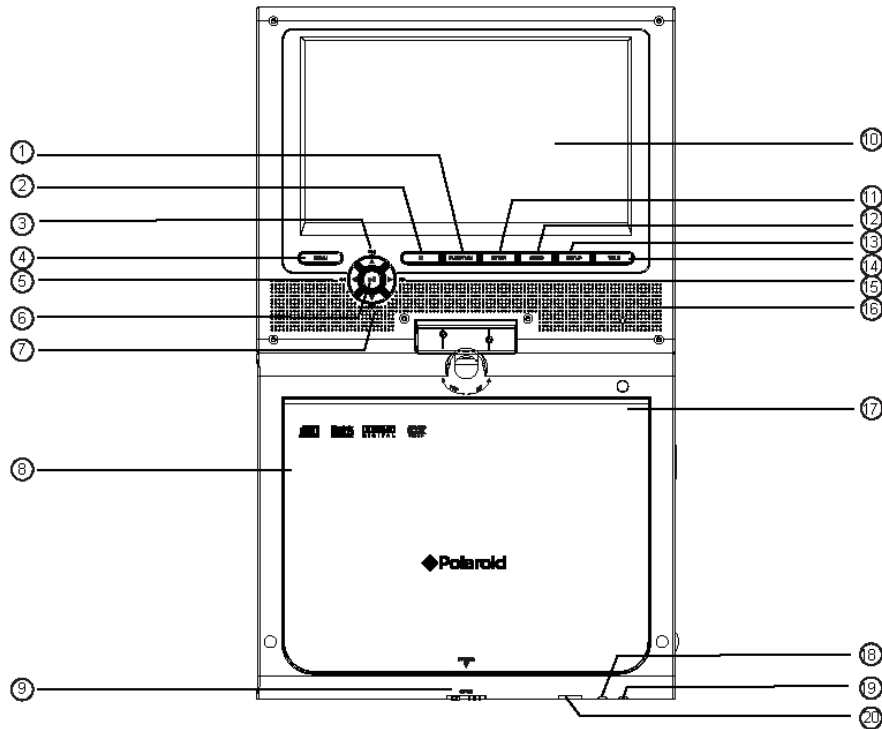

1. **FUNCTION button:** press to enter the brightness, contrast, or color adjusting mode
2. **■ button:** press to stop playback or press it twice to stop completely
3. **▲/◀◀ button:** press ▲ to select different items; press ◀◀ to go to previous list/track/chapter
4. **MENU button:** press to access the DVD disc menu during playback
5. **◀/◀◀ button:** press ◀ to select different items; press and hold ◀◀ to search backwards fast
6. **▶/|| button:** press to pause the playback
7. **▼/▶▶ button:** press ▼ to select different items; press ▶▶ to go to next list/track/chapter
8. **Disc tray:** when the disc tray is loaded, gently press the cover to close it
9. **OPEN switch:** push to open the disc tray cover
10. **LCD screen**
11. **ENTER button:** press **ENTER** to confirm selection
12. **AUDIO button:** press to access the DVD disc language during playback
13. **SETUP button:** press to access or exit the system setup menu
14. **TITLE button:** press to display the title menu
15. **▶/▶▶ button:** press ▶ to select different items; press and hold ▶▶ to search forward fast
16. **Speaker**
17. **LCD on/off switch**
18. **Working/Standby indicator**
19. **Charge indicator:** light is red when the battery is being charged; green when battery is fully charged.
20. **Remote sensor**

* Your portable DVD player may differ from the player shown.

View of Side Panel*

Side View

1. **Volume Control Knob:** Used to adjust the volume of headphones and speaker
2. **Headphone Jack:** Used to connect to headphones for private listening. When headphone is plugged in, the speakers will automatically turnoff.
3. **Headphone Jack**
4. **Audio/Video Output Jack:** For connecting to an external amplifier or monitor source
5. **Power ON/OFF Switch:** Switch the power on or off
6. **DC 9/12V Input Jack:** Used to connect the DC 9/12V adaptor

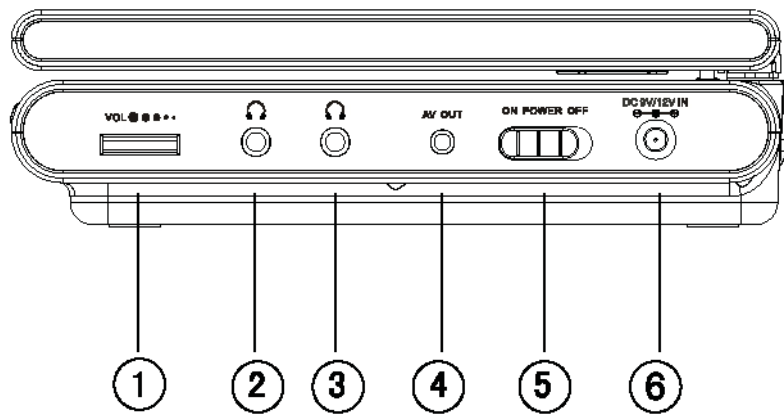

* Your portable DVD player may differ from the player shown.

View of Bottom Panel*

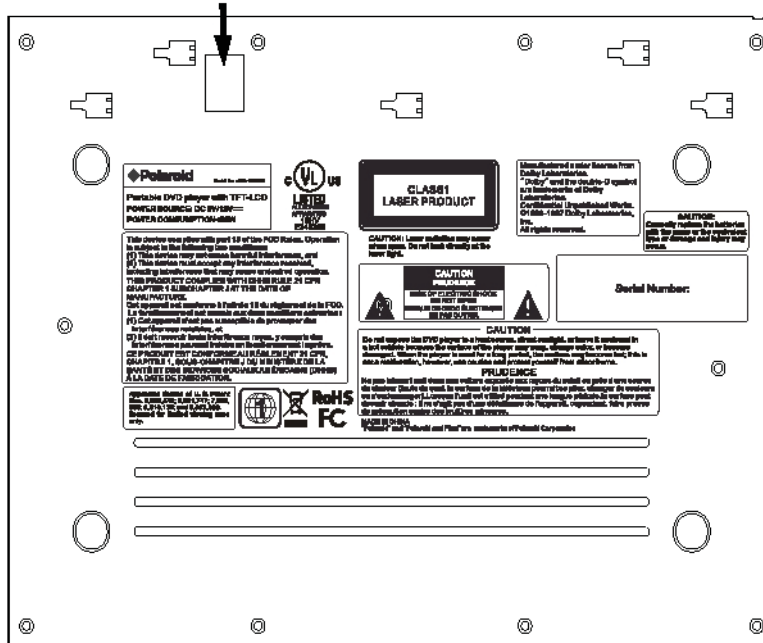

1. Rechargeable Battery Contacts: For connecting the rechargeable battery pack





Note: All markings are on the bottom of the portable DVD player.

* Your portable DVD player may differ from the player shown.

Revolving LCD Screen

Revolving LCD Screen

The revolving LCD screen is one of the outstanding features about this product. Here are some suggested steps for proper operation:

<p>A</p>  <p>The image shows a black DVD player with its LCD screen open and positioned vertically, perpendicular to the front panel. An upward-pointing arrow is located to the right of the device.</p>	<p>Open the screen cover to position (A) as shown at left, where the screen is vertical to the operation panel.</p>
<p>B</p>  <p>The image shows the DVD player with the screen rotated clockwise from its vertical position. The screen is now at an angle towards the front panel.</p>	<p>Revolving the screen horizontally about its axis in the clockwise only. The maximum revolving degree is 180 (position C). If you want to return to initial position (A), please revolve the screen counterclockwise until it clicks.</p>
<p>C</p>  <p>The image shows the DVD player with the screen open and positioned vertically, perpendicular to the front panel, identical to position A.</p>	<p>You can rotate the screen vertically from position (C) to the operation panel as shown at left.</p>
<p>D</p>  <p>The image shows the DVD player with the screen closed and lying flat against the front panel. A downward-pointing arrow is located to the right of the device.</p>	<p>The final position (position D) is when the screen faces upwards and back to operation panel.</p>

Remote Control*

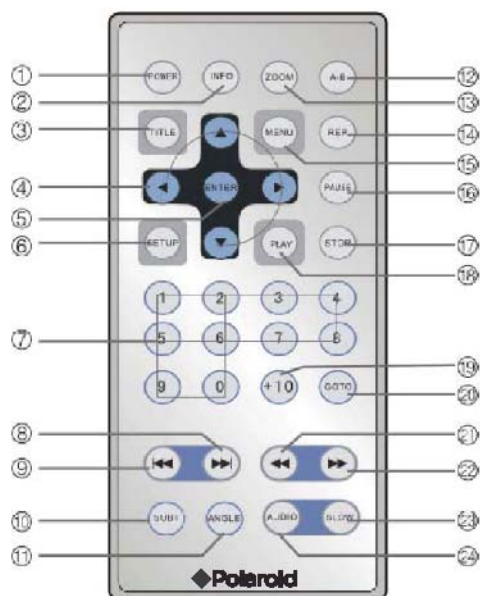

1. **POWER button:** press to turn unit on or off
2. **INFO button:** press repeatedly to display or cancel the detailed information of the disc during playback
3. **TITLE button:** press to display the title menu if it exists on the disc
4. **Direction button:** press to select different options
5. **ENTER button:** press to access playback or confirm your selection
6. **SETUP button:** press to enter the player's setup menu
7. **0-9 number buttons:** press to select numbers
8. **▶▶ NEXT button:** press to skip to the next list, track, or chapter
9. **◀◀ PREV button:** press to return to the previous list, track, or chapter
10. **SUBT button:** press to select a subtitle language or to turn the subtitles on or off (when playing a disc coded with subtitles)
11. **ANGLE button:** press to access various camera angles if the DVD disc contains multiple camera angles
12. **A-B button:** press to play a section of the disc from point A to point B. Press once to select the starting point A, press again to select the end point B. During A-B repeat playback, press this button to stop the repeat
13. **ZOOM button:** press to realize different zoom functions
14. **REP button:** press to repeat a chapter, title, or entire disc
15. **MENU button:** press to access the DVD disc menu during playback
16. **PAUSE button:** press to pause playback, press the PLAY button to resume normal playback
17. **STOP button:** press stop to stop playback, press twice to stop completely. Press the PLAY button to resume playback.
18. **PLAY button:** press to start playback
19. **+10 button:** press the 10+ button followed by another number to select a number greater than 9
20. **GOTO button:** press to select the desired disc starting time, title, or chapter
21. **◀◀ REV SCAN button:** press to search backward during playback
22. **▶▶ FWD SCAN button:** press to search forward during playback
23. **SLOW button:** press to activate slow playback function
24. **AUDIO button:** press to select different languages when a DVD disc with multiple audio languages is being played; press to select different audio tracks when a CD disc is being played

* Your portable DVD player may differ from the player shown.

Remote Control

Installing the Remote Control Battery

1. Pull the battery holder out from the remote control as shown below.
2. Load a new battery properly with the (+) side up.
3. Insert the battery holder back into the remote control.

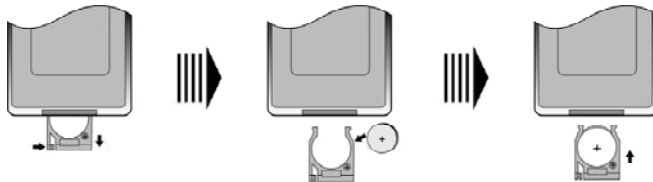

Battery Type: CR2025 3V

Battery service life: approximately 1 year under normal use (at room temperature)

Using the Remote Control

Point the remote control to the remote sensor on the player within a 5-meter range and 60-degree angles, without obstacles between the remote control and remote sensor.



Notes:

- Improper use of the battery may cause overheating, explosion or ignition, which can result in an injury or fire. Battery leakage may damage the remote control.
- Do not expose the remote control to direct sunlight.
- Do not recharge, disassemble, deform, or heat the battery.
- Immediately replace the exhausted battery.
- Take out battery when the remote is not being used for a long period of time.

System Connections

- Always ensure that the DVD player, TV, and any other electrical equipment to be connected are switched off and unplugged from the power supply.
- Ensure that you observe the color coding when connecting audio and video cables.

Connecting to a TV

Follow the drawing below to connect the DVD player to the TV's audio/video input with the audio/video cables.

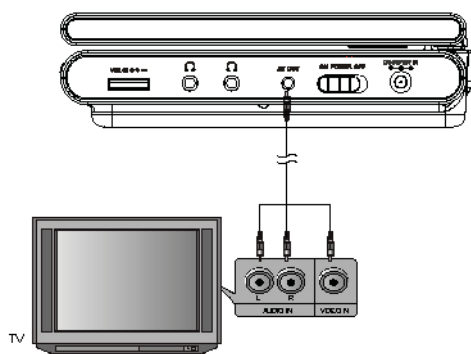

Connecting to an Amplifier

Refer to your audio equipment's manual before connecting. Follow the drawing below to connect the DVD player to an AV amplifier.

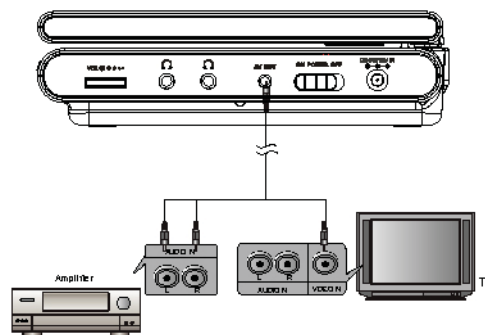

Connecting to the Headphones

Connect the headphones to the headphone jack on either side of the player. When headphones are connected, the speakers will automatically turn off.

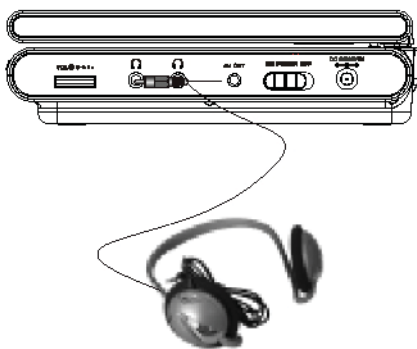

Connecting to a Gaming System

On your gaming system, use a gaming adapter (coupler)* to connect the RCA cables from your gaming system to the RCA cables from your portable DVD player. Connect the connected RCA cables to the gaming system and portable DVD player, turn on the portable DVD player and gaming system, and press the AV IN/OUT button on the portable DVD player to play.

* Gaming adapter not included with all portable DVD players.

Power Supply

Using the AC Adapter

The player is supplied with an AC adapter for powering the player and charging the battery.

1. Connect the AC adapter to the left side of the DVD player marked DC 9/12V IN.
2. Plug the two-prong end of the power cord into a grounded electrical outlet.

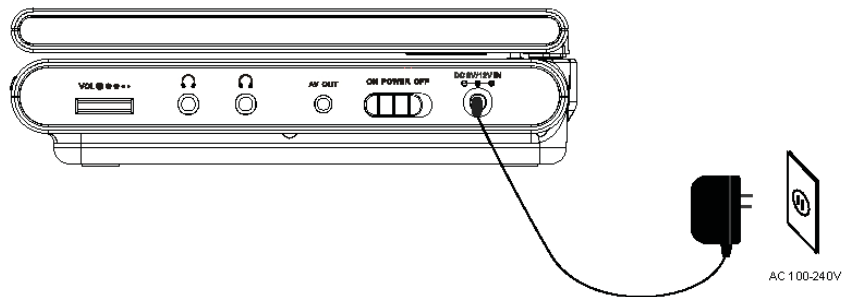

Notes:

- Turn the play
- When using the adapter, the LCD screen will be brighter than using the rechargeable battery.

Using the Car Adapter

The player is supplied with a car adapter for powering the player and charging the battery in a vehicle.

Connect the car adapter power plug to the player's power jack and the other end to the vehicle's 12V accessory/ cigarette lighter socket.

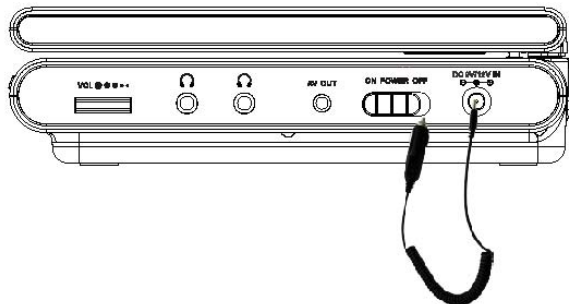

Attention:

- Do not operate the player or view video software while driving a vehicle.
- Place the player in a proper viewing position.
- Detach the battery pack when using the AC or car adapter as a power source.
- Disconnect the player from the car adapter when starting the vehicle.

Rechargeable Battery

About Your Rechargeable Battery Pack

Your portable DVD player may come with a lithium ion polymer rechargeable battery that attaches to the bottom of the DVD player. Charge the battery fully before initial use. Charging time is normally about 5 hours. A fully-charged battery delivers about 2.5 hours of use, but playing time varies disc to disc. If the battery will not be used for a long period of time, charge the battery fully before storing.

Working conditions and precautions for the rechargeable battery

1. New battery should be fully charged before initial use
2. Battery should only be used and charged when temperature is between 32-100° F
3. Never put the battery in fire or water
4. Do not expose the battery to high temperatures or store in a hot, sunny place
5. Maintain well-ventilated conditions around the product to avoid overheating. Do not put the product on a bed, sofa, or anything that may block ventilation to the product
6. Do not short the battery terminals
7. Do not open the battery
8. Detach the battery after charging is complete. When charging the battery pack, the charge light will turn red; when the charging is complete, the light will turn green
9. Detach the battery when it is not in use
10. When the charge of the battery is wear, low power indicator will appear on the LCD screen. The player will turn off automatically about five minutes later.

Warning: Do not touch any metal object to the battery connectors as it will put the battery in standby mode. To exit standby mode, connect the battery and DVD player to AC or DC power.

Rechargeable Battery

Attaching the Battery Pack

1. With one hand on the DVD player to prevent it from moving, take the battery and align the plastic tabs on the battery pack with the holds on the player, and push the battery pack into the DVD player.
2. Slide the battery pack until you hear it click and lock in place.



Charging the Battery Pack

The battery pack must be attached to the DVD player to charge it by using the supplied AC power adapter.

1. Attach the battery pack to the DVD player.
2. Plug the supplied AC power adapter into the player's jack marked "DC 9/12V IN", which is located on the right side of the DVD player.
3. Plug the other end of the AC power adapter cord into a household AC outlet as shown below:



Detaching the Battery Pack

When being turned off, the DVD player still consumes some power in standby mode. This will eventually discharge the battery. If the DVD player is not going to be used for long periods of time, the battery pack should be detached.



Make sure the power is turned off before detaching the battery pack.

1. Press and hold the battery release tab in the direction of arrow 1 as shown in figure 1 below.
2. Slide the battery pack gently towards the direction of arrow 2 as shown in figure 1 below.
3. Carefully remove the battery pack from your player.



Notes on Discs

Compatible Disc Formats

	DISC LOGO	DIAMETER	PLAYBACK TIME / PLAYABLE SIDES
DVD		12 cm	133 min (SS-SL) 242 min (SS-DL) 266 min (DS-SL) 484 min (DS-DL)
		8 cm	41 min (SS-SL) 75 min (SS-DL) 82 min (DS-SL) 150 min (DS-DL)
CD		12 cm	74 min
		8 cm	20 min
JPEG		12 cm	

Operation methods of some DVD discs are specified by the software manufacturer. Please follow the instructions of the disc.

Care of Discs

Holding Discs

- When loading or removing discs, try not to touch their play surfaces.



Cleaning Discs

- Fingerprints or stains on the disc may affect the quality of sound and picture. To clean your discs, use a soft clean cloth to wipe them. If necessary, moisten a soft cloth with neutral detergent to remove heavy dirty or fingerprints.
- Do not wipe in a circular direction (concentric scratches on the disc groove tend to cause noise). Gently wipe from center of the disc to the outer edge.

Playback Operation*

Please read the following instructions carefully before using your DVD player for the first time.

Warning: To avoid damaging the lens, do not play poor quality discs.

Pre-Operation

1. Connect the player to power supply through the provided AC adaptor.
2. Switch POWER ON/OFF to ON to turn the DVD player on.
3. Push the OPEN switch on the player to open the disc tray cover. Put a disc in the disc tray with printed side up. Close the disc cover.
4. The player will search the disc and play it automatically.
5. Adjust the volume with the VOLUME control on the right panel to the desired level.
6. To turn the player off, switch the POWER ON/OFF to off.



* Your portable DVD player functions may differ from the player shown.

Playback Operation

Features are available on both the DVD player and remote control unless otherwise noted.

DVD Playback

ENTER button	When you load a disc in, the player will search the disc and play it automatically. Press the direction buttons (▲▼◀▶) to highlight the item you want to play and press the ENTER button to confirm.
PAUSE/ button	Press the PAUSE/ button to pause during playback and the PLAY ► button to resume normal playback.
STOP/ ■ button	Press the STOP/ ■ button once to stop playback. Then press the PLAY ► button to resume normal playback from the place where the STOP button was pressed. Press the STOP/ ■ button twice to stop playback completely.
MENU button	Press the MENU button during playback. The root menu will appear on the screen. Press the direction buttons (▲▼◀▶) to select the item you want to play and press the ENTER button to confirm. You can also press the 0-9 and +10 buttons to select the item you prefer.
TITLE button	In general, the content of a DVD disc can be divided into several titles. There are also several menus in a title. Press the TITLE button during playback. The title menu will appear on the screen. Press the direction buttons (▲▼◀▶) to select the title or disc menu item you want to watch and then press the ENTER button to confirm. You can also press the 0-9 and +10 buttons to select the item you prefer. (remote only)
ZOOM button	Press the ZOOM button repeatedly to shift among 1x - 2x - 3x - 4x - 1/2x - 1/3x - 1/4x zooming effect and normal playback.
◀◀ & ▶▶ buttons	Press the ◀◀ button to go to the previous chapter. Press the ▶▶ button to go to the next chapter.
◀◀ & ▶▶ buttons	Press the ◀◀/▶▶ button (and hold it for several seconds) to start fast forward/rewind playback. Press it (and hold it for several seconds) repeatedly to fast forward/rewind at the speed of 2x, 4x, 8x, 20x, and normal playback. Press PLAY to return to normal playback.
SLOW button	Press the SLOW button repeatedly and slow playback will at the speed of 1/2, 1/3, 1/4, 1/6, 1/7, and normal playback. During slow playback, press the PLAY button to resume normal playback.
REP button	Press the REP button to repeat a Chapter, All, or cancel repeat in sequence. (remote only)
A-B button	In normal playback, press the A-B button to select the segment you want to play repeatedly. Press once to select the starting point A, press again to select the end point B; the player will play the segment between A and B continuously. Press the A-B button a third time to cancel the repeat segment.
GOTO button	During playback, press the GOTO button repeatedly to enter the menu to select desired TITLE, CHAPTER, or TIME. Use the ◀▶ direction buttons to select the item you want to set. Use the 0-9 and +10 buttons to select directly and then press the ENTER button to confirm. Press the GOTO button again to exit. (remote only)

Playback Operation

DVD Playback (continued)

INFO button	Press to display or cancel the detailed information of the disc during playback. (remote only)
AUDIO button	DVD discs can contain up to 8 audio bit streams. For example: English, French, etc. To select the audio bit stream you prefer, press the AUDIO button during playback. The DVD player will play the next audio bit stream every time you press the AUDIO button in succession. (remote only)
SUBT button	When a DVD is playing, press the SUBT button to select a subtitle language or to turn subtitles off. A DVD disc can be recorded with at most 32 subtitles. Note: this function is only available for discs recorded with multi-subtitles. (remote only)
ANGLE button	Press the ANGLE button to play the disc in multi-angle. Multi-angle means that a scene is shot from different angles so the audience can watch from any angle. If there are multiple angles in a scene, you can use the ANGLE button to select the angle you enjoy. Press the ANGLE button repeatedly to view different angle options. Note: this function is only available for DVD discs coded with multi-angle.

CD Playback

PAUSE/ button	Press the PAUSE/ button to pause during playback. Press the PLAY/ ► button to resume normal playback.
STOP/ ■ button	During playback, press the STOP/ ■ button once to stop and then press the PLAY/ ► button to resume normal playback from the place where the STOP/ ■ button is pressed. Press the STOP/ ■ button twice to stop playback completely.
▶▶ & ◀◀ buttons	Press the ▶▶/◀◀ (and hold it for several seconds) to play fast forward/rewind. Press it (and hold it several seconds) repeatedly, the fast forward/rewind playback will be play at the speed of 2x, 4x, 8x, 16x, 32x in sequence. Press the PLAY/ ► button to return to normal playback.
◀◀ & ▶▶ buttons	Press the ◀◀ button to play the previous chapter. Press the ▶▶ button to play the next chapter.
GOTO button	During playback, press the GOTO button repeatedly to enter the menu to select desired track, time track, or disc time. Use the ◀▶ direction buttons to select the item you want to set. Use the 0-9 and +10 buttons to select directly and then press the ENTER button to confirm. Press the GOTO button again to exit. (remote only)
INFO button	Press the INFO button repeatedly to display or cancel detailed information during playback. (remote only)
REP button	Press the REP button repeatedly to repeat a Track, All, or cancel repeat in sequence. (remote only)
AUDIO button	Press the AUDIO button to select the desired sound effect. Press it repeatedly and the display will be as follows: Mono L → Mono R → Mix Mono → Stereo. (remote only)

Playback Operation

JPEG Playback

Pre-Operation

1. Load a JPEG in the disc tray and the player will search and play the disc automatically.
2. The screen displays the root folder with several subdirectories/sub-folders. Use the ▲▼ buttons to select desired folder. Then press the ENTER button to confirm your selection.
3. The screen enters the sub-folder with several files. Use the ▲▼ buttons to select desired file. Then press the ENTER button to confirm your selection.
4. Press the ◀ button to return to the previous folder or directory.

Note: many discs have other items besides pictures.

Buttons Operation

STOP/ ■ button	Press the STOP / ■ button to return to the previous folder. Press the direction buttons (▲▼◀▶) to select the picture you prefer and then press the ENTER button to resume normal playback.
PAUSE/ button	Press the PAUSE/ button to pause during playback. Press the PLAY/ ▶ button to resume normal playback.
MENU button	Press the MENU button to return to the previous folder. Press the direction buttons (▲▼◀▶) to select the picture you prefer and then press the ENTER button to resume normal playback.
⏮ & ⏭ buttons	Press the ⏮ button to play the previous chapter. Press the ⏭ button to play the next chapter.
ZOOM button	Press the ZOOM button repeatedly to shift among 2x, 3x, 4x, 1/2, 1/3, 1.4 zooming in and out effect and normal playback.
GOTO button	During playback, press the GOTO button to select the desired file. Press the 0-9 buttons directly to select according to your preference. (remote only)
REPEAT function	Under folder status, press the ▶ button to enter REPEAT setup. Then press the ENTER button repeatedly to set the repeat mode and the screen will display as follows in sequence: REP 1 → REP DIR → REP ALL → OFF. Press the ◀ button to exit. (remote only)

Playback Operation

JPEG Playback (continued)

Rotating Pictures

While viewing a picture, use the direction buttons to rotate the picture.

Press the ◀ button to rotate the current picture clockwise:

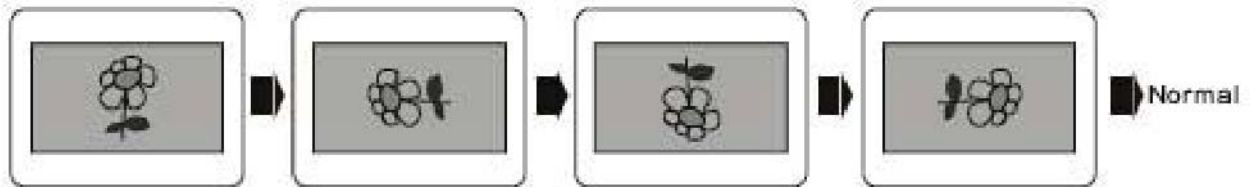

Press the ▶ button to rotate the current picture counterclockwise:

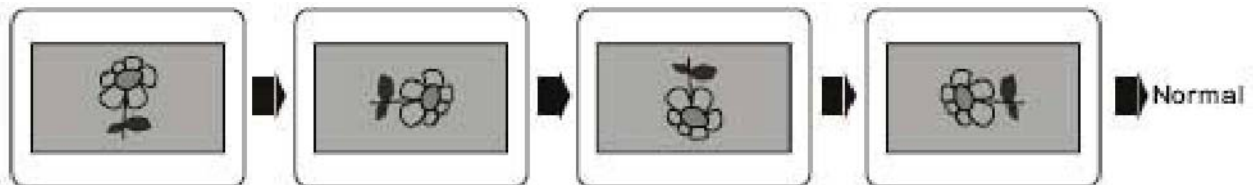

Press the ▲ button to rotate the current picture up and down:

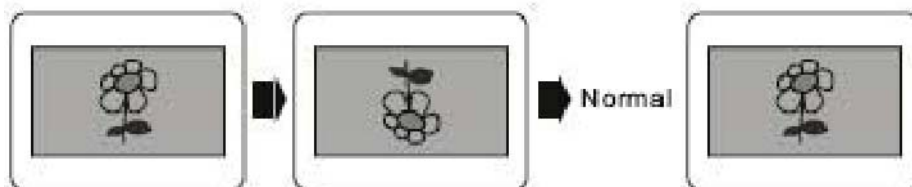

Press the ▼ button to rotate the current picture left and right:

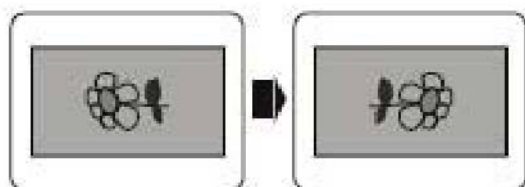

System Setup*

You can change the default settings of this player to customize its performance to your own preferences.

Note: Program the system while playback is stopped completely or there is no disc in the payer.

To Set up your system:

1. Press the SETUP button and the setup menu will appear on the screen.
2. Press the direction buttons to select a sub-menu to program and press the ENT/ENTER button to access.
3. Press the SETUP button again to exit the setup menu at any time during setting.

General Setup



SCREEN SAVER

- This item is used to turn on and off the screen saver.
- Press the ▲▼ buttons to highlight this item.
- Press the ► button to access.
- The default setting of this player is on.
- Press the ▲▼ buttons to choose on or off.
- Press the ENT/ENTER button to confirm your selection.
- Press the ◀ button to exit.



TV TYPE

This item is used to set the TV display mode.

- Press the ▲▼ buttons to highlight this item.
- Press the ► button to access.
- It includes 4:3 PS, 4:3 LB, and 16:9.
- Press the ▲▼ buttons to choose the desired language.
- Press the ENT/ENTER button to confirm your selection.
- Press the ◀ button to exit.

Note: Select 4:3 PS or 4:3 LB when a 4:3 TV is connected. Select 16:9 when a 16:9 wide screen TV is connected.



DEFAULT

- This item is used to reset the player.
- Press the ▲▼ buttons to highlight this item.
- Press the ► button to access.
- Press the ENT/ENTER button to reset. All settings to your unit are now set back to its original state.
- Press the ◀ button to exit.

* Your portable DVD player functions may differ from the player shown.

System Setup

Language Setup



OSD LANGUAGE

- This item is used to set the OSD (on-screen display) language.
- Press the ▲▼ buttons to highlight this item.
- Press the ► button to access.
- There are several languages for you to choose.
- Press the ▲▼ buttons to choose the desired language.
- Press the ENT/ENTER button to confirm your selection.
- Press the ◀ button to exit.



AUDIO LANGUAGE

- This item is used to set the audio language
- Press the ▲▼ buttons to highlight this item.
- Press the ► button to access.
- There are several languages for you to choose.
- Press the ▲▼ buttons to choose the desired language.
- Press the ENT/ENTER button to confirm your selection.
- Press the ◀ button to exit.



SUBTITLE LANGUAGE

- This item is used to set the subtitle language
- Press the ▲▼ buttons to highlight this item.
- Press the ► button to access.
- There are several languages for you to choose.
- Press the ▲▼ buttons to choose the desired language.
- Press the ENT/ENTER button to confirm your selection.
- Press the ◀ button to exit.



MENU LANGUAGE

- This item is used to set the menu language
- Press the ▲▼ buttons to highlight this item.
- Press the ► button to access.
- There are several languages for you to choose.
- Press the ▲▼ buttons to choose the desired language.
- Press the ENT/ENTER button to confirm your selection.
- Press the ◀ button to exit.

Definitions

Letterbox screen

This refers to a screen on which the playback picture of wide-screen DVDs is cut off at the left and right sides.

Pan & Scan screen

This refers to a screen on which the playback picture of wide-screen DVDs appears with black bands running along the top and bottom.

Title, Chapter (DVD)

DVDs are divided into some large sections (titles) and some small sections (chapters). Each section is numbered as chapter or title numbers

Title 1	Title 2
Chapter 1	Chapter 1
Chapter 2	
.....

Track (CD)

CDs are divided into some sections (tracks). Each section is numbered as tracks.

Track 1	Track 2	Track 3
---------	---------	---------	-------

JPEG

JPEG is a common picture format that has small file size and low quality-loss rate of picture. Hundreds of pictures can be stored in a disc in this format. In order to utilize the real digital album, use film to make a picture CD in JPEG format.

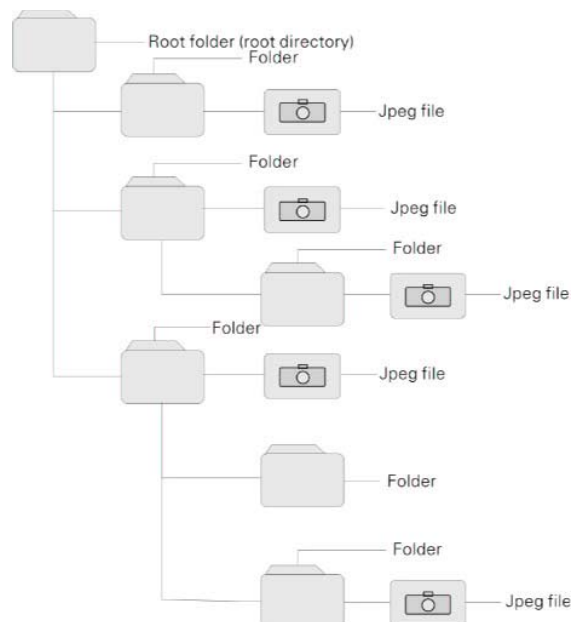

Troubleshooting

If you suspect there is something wrong with the DVD player, immediately turn off the power. Disconnect the power connector and check that there is no smoke or excessive heat coming from the player.

Never open or try to repair the player yourself. There are no user serviceable parts inside.

PROBLEM	POSSIBLE CAUSE	POSSIBLE SOLUTION
The player cannot play	<ul style="list-style-type: none"> The disc cover may not be closed. There may be no disc in the DVD drive. The disc may not be put in the right way. The disc may be dirty or warped. The player's region code may not be the same as the disc's region code. There may be water on the lens. 	<ul style="list-style-type: none"> Close the disc cover. Put a disc in to the DVD drive. Put the disc in with the label side up. Clean or change the disc. Make sure the player's region code is the same as the DVD's region code. Remove the disc and keep the player turned off for at least two hours.
There is no sound	<ul style="list-style-type: none"> The system connection may be incorrect. The speakers may be turned down. The sound setup of the DVD may be incorrect. The disc may be dirty or warped. 	<ul style="list-style-type: none"> Connect the system correctly. Turn on the speakers. Setup the sound of the DVD correctly. Clean or change the disc.
There is no picture	<ul style="list-style-type: none"> The LCD may not be in correct video mode. The system connectivity may be incorrect. 	<ul style="list-style-type: none"> Choose the correct video mode. Connect the system correctly.
Poor AV performance	<ul style="list-style-type: none"> The disc may be dirty or warped. 	<ul style="list-style-type: none"> Clean or change the disc.
The remote control does not work	<ul style="list-style-type: none"> There may be some obstructions between the remote control and the player. The remote control may not be pointed at the player. The remote control battery may be inserted incorrectly. The remote control batteries may be out of power or weak. 	<ul style="list-style-type: none"> Remove the obstruction between the remote control and the player. Point the remote control directly at the player. Make sure the polarity of each battery is correct. Replace the batteries.

Other possibilities: Static or external interference may cause the player to function abnormally. In order to recover normal status, please unplug the power-supply cord and then plug it into the outlet again to reset the player. If the problems still exist, please cut off the power supply and consult your service center or qualified technician.

Specifications

TFT Screen Size	7 inches (16:9)	8 inches (16:9)	8.5 inches (16:9)	10 inches (16:9)
Screen Resolution	480 x 234	480 x 220	480 x 234	480 x 234
Laser Wavelength	780/650nm	780/650nm	780/650nm	780/650nm
Frequency Response	20Hz-20kHz ± 2.5dB	20Hz-20kHz ± 2.5dB	20Hz-20kHz ± 2.5dB	20Hz-20kHz ± 2.5dB
Audio Signal-to-Noise Ratio	≥ 85dB	≥ 85dB	≥ 85dB	≥ 85dB
Audio Distortion+Noise	≤ -70dB (1kHz)	≤ -70dB (1kHz)	≤ -70dB (1kHz)	≤ -70dB (1kHz)
Channel Separation	≥ 70dB (1kHz)	≥ 70dB (1kHz)	≥ 70dB (1kHz)	≥ 70dB (1kHz)
Dynamic Range	≥ 80dB (1kHz)	≥ 80dB (1kHz)	≥ 80dB (1kHz)	≥ 80dB (1kHz)
Audio Out	Out Level 2V±0.2 1.0, Load 10kΩ	Out Level 2V±0.2 1.0, Load 10kΩ	Out Level 2V±0.2 1.0, Load 10kΩ	Out Level 2V±0.2 1.0, Load 10kΩ
Video Out	Out Level 1V±0.2, Load 75Ω Unbalanced Negative	Out Level 1V±0.2, Load 75Ω Unbalanced Negative	Out Level 1V±0.2, Load 75Ω Unbalanced Negative	Out Level 1V±0.2, Load 75Ω Unbalanced Negative
Dimensions	230mm x 170mm x 43mm	230mm x 170mm x 43mm	230mm x 170mm x 43mm	265mm x 170mm x 43mm
Weight	Approximately 0.93kg	Approximately 0.93kg	Approximately 0.93kg	Approximately 1.23kg

DESIGN AND SPECIFICATIONS ARE SUBJECT TO CHANGE WITHOUT NOTICE

Manufactured under license from Dolby Laboratories.
 “Dolby” and the double-D symbol are trademarks of Dolby Laboratories.
 Confidential unpublished works. © 1992-1997 Dolby Laboratories, Inc.
 All rights reserved.

For service, support and warranty information, visit www.polaroid.com.

“Polaroid” and “Polaroid and Pixel” are trademarks of Polaroid Corporation.